

UPGLASS

Glass Systems



UPGLASS

Glass Systems

Matek Grup Upglass is a fully automatic, remote controlled, 100% cleanable, motorized vertical glass system. Upglass telescopic guillotine lenses are a very high quality and stylish solution with a high production standard. It also offers optimum performance in terms of thermal insulation, daylight, bright living space and energy saving.

Matek Grup Upglass is a customized architectural glass solution, and different configurations can be created according to the needs of your space. Upglass, an extremely durable and stylish movable glass system, is ideal for restaurants, terraces and gardens. Matek Grup Upglass with its patented design offers 100% cleaning from inside, even on high floors.

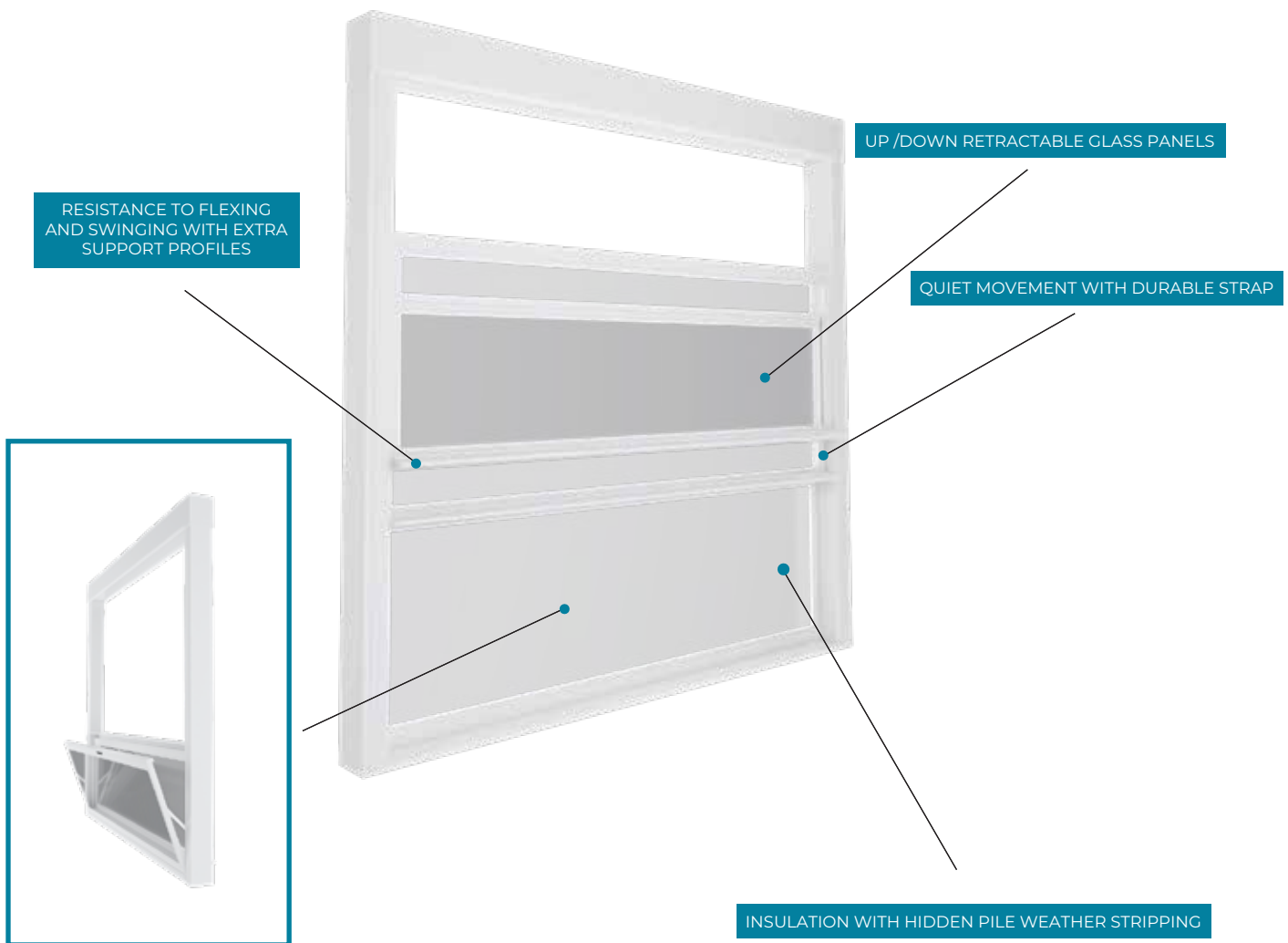

You can customize selecting the colour of your choice from more than 1600 existing RAL colors.

Upglass / Technical Data

Extra Support Profile

Matek Grup Upglass can be applied as a single module up to 5000 mm wide with its patented extra support profile. These wide-angle glasses provide a perfect view.

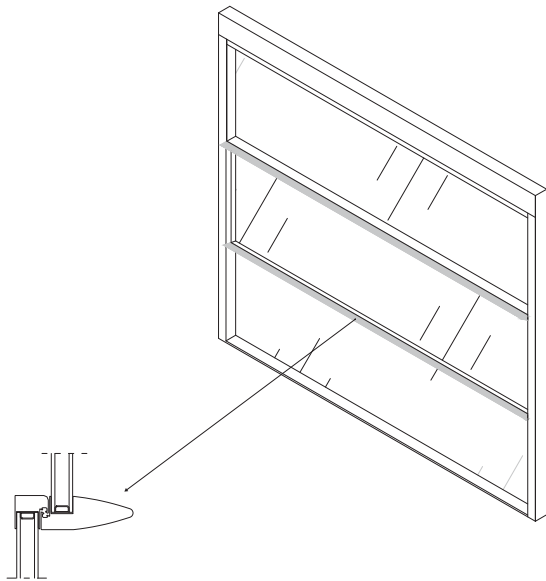

100% CLEANABLE DESIGN

The patented design of Upglass offers the opportunity to clean the inside and outside of the glass fully, even in high buildings. This cleaning can be done easily from the inside of the building.

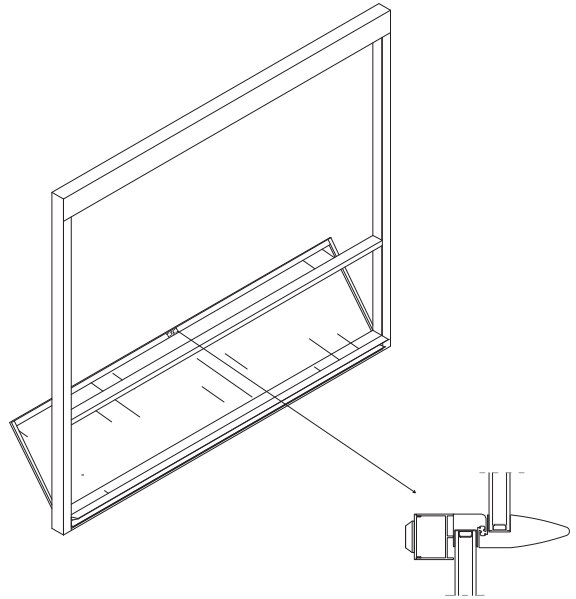

Maximum width for each module	5000x2800 mm
Extra support profile	Optional
100% cleanable mechanism	Optional
Glass thickness /Air gap	4 mm/ 16 mm AG/4 mm - 5 mm/14 mm AG/5 mm
Glass features	Tempered insulating glass
Solar Low-E glass	Optional
Glass colour	Optional
Number of glasses for each module	2 - 3 - 4
Extruded aluminum	✓

Flexibility to be applied to different areas and sizes	✓
Durability	✓
Easy cleaning and maintenance	✓
Maximum protection against weather conditions	✓
Motorized	✓
Curtain systems	Optional
Awning systems	Optional
Colour	Single / Multi
Powder Coated	✓

- 1** 3 glass panel system
1 glass panel stable
2 glass panel movable to down
Single module

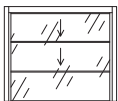

- 2** 4 glass panel system
1 glass panel stable
3 glass panel movable to down
Double module

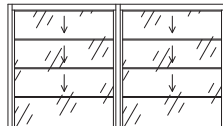

- 3** 3 glass panel system
1 glass panel stable
2 glass panel movable to down/up
Triple module

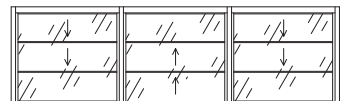

- 4** 2 glass panel system
1 glass panel stable
1 glass panel movable to down
Single module

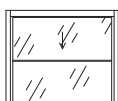

- 5** 2 glass panel system
1 glass panel stable
1 glass panel movable to down/up
Double module

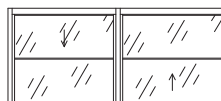

- 6** 2 glass panel system
1 glass panel stable
1 glass panel movable to down/up
Triple module



MATEK GRUP UPGLASS OFFERS “UNOBSTRUCTED VISION” WITH ITS MAXIMUM SHARPNESS RANGE VERTICAL FRAMELESS AND MINIMALISTIC HORIZONTAL FRAME



Aluminum



Stainless Component

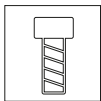

Motorized System

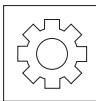

Remote Control



2 Years Warranty

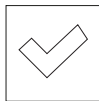

Tempered Glass

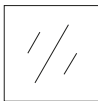

Eco Friendly

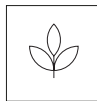

Water Proof

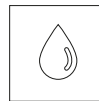

Insulation

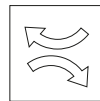

CE Certified



MATEK GRUP
LIVING SPACE SOLUTIONS

Gümüşsuyu Cd. Fatih Şehitler Sk. No:4 Topkapı / ISTANBUL / TURKIYE
+90 (212) 501 27 28 - info@matekgrup.com.tr / www.matekgrup.com.tr

f @ matekgrup

ONLINE CATALOGUE
FOR ALL PRODUCTS

