

# LUNA

## Pergola



# LUNA

## Pergola

Matek Grup Luna is a retractable motorized pergola system made of fabric and aluminum.

Luna completely protects your space against external weather conditions and turns it into a comfortable living space. Flexible in function and stylish in design, these pop-up roof systems offer the best in both form and function. Maximum water and UV sun protection can be achieved by using a flexible PVC fabric awning.

A powder-coated aluminum frame is used to support the fabric canopy. You can control the system as you wish with the remote control.

Matek Grup Luna offers the optimum solution for both home and commercial spaces.

ABRASION AND FADING RESISTANT FABRIC

INTEGRATED LED LIGHTING

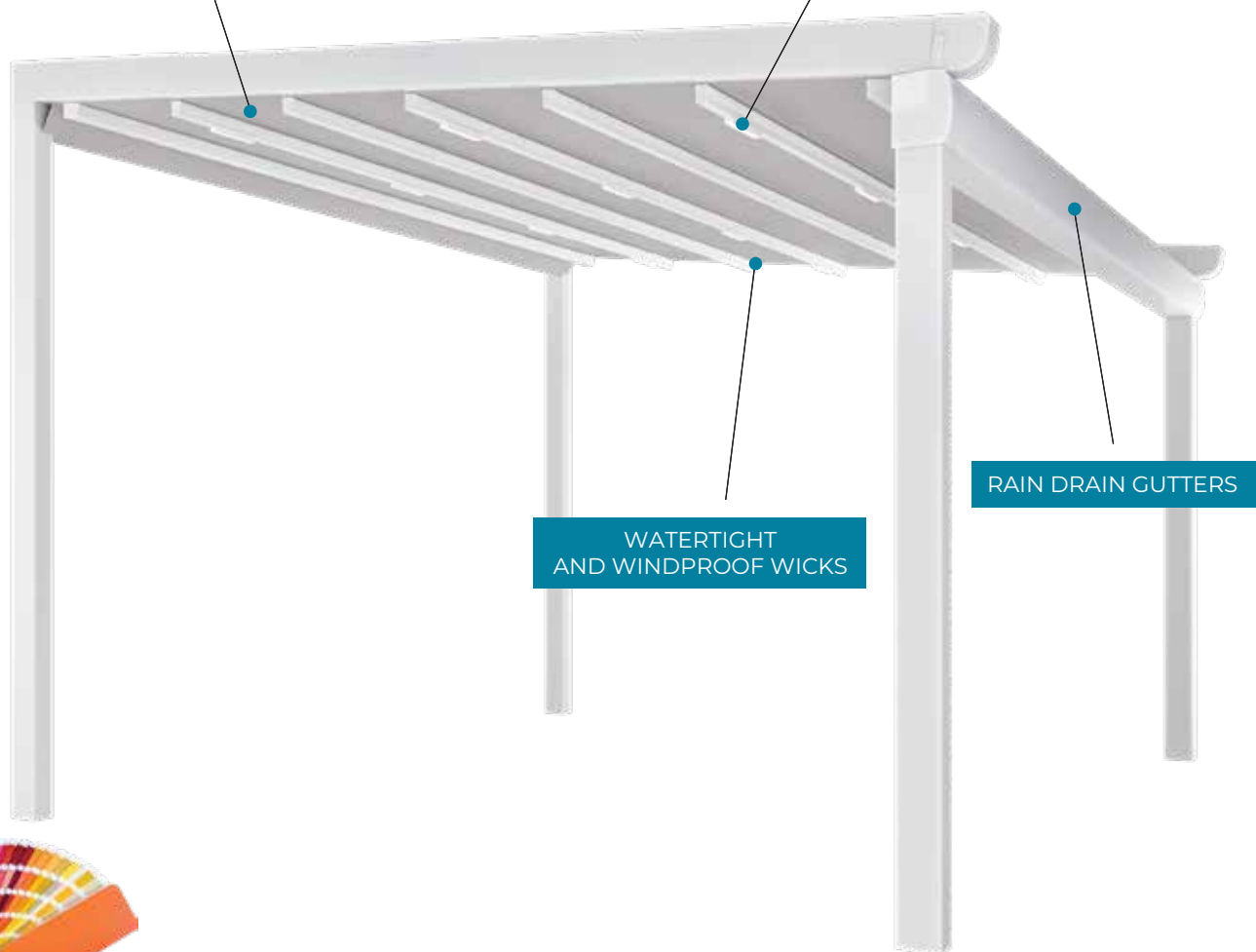

You can customize selecting the colour of your choice from more than 1600 existing RAL colors.

# Luna / Technical Data

## RETRACTABLE

Matek Grup Luna can be easily retractable with its motorized system and remote control, it can be stopped at the desired point. This feature allows maximum comfort and ventilation in the living area.

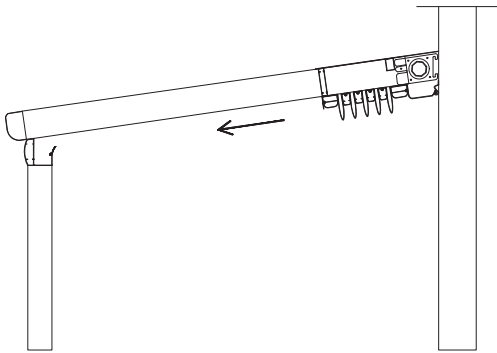

## INSULATION

Matek Grup Luna offers excellent durability even for the toughest weather conditions with its special fabric, which allows long life with its excellent resistance against abrasion and UV. It provides perfect insulation with special wicks at the joints.

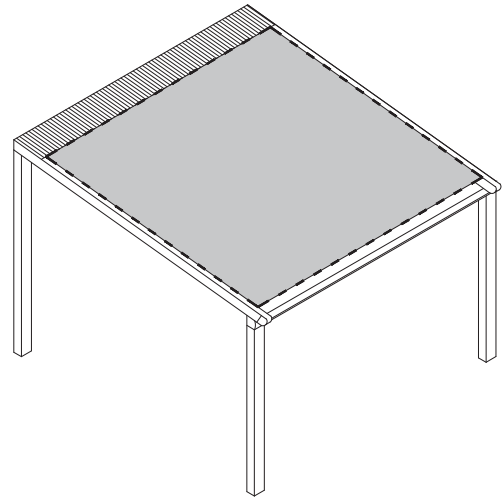

Maximum width for each module	4000 mm
Maximum depth for each module	6000 mm
Type of fabric	PVC based, Blackout
Self-standing / Wall-mounted	✓
Height	Optional
Minimum slop	12° - 15° %
Extruded aluminum	✓
Flexibility to be applied to different areas and sizes	✓
Durability	✓

Easy cleaning and maintenance	✓
Maximum protection against weather conditions	✓
Motorized	✓
Curtain systems	Optional
Glass systems	Optional
Lighting	Integrated LED
Fade and abrasion resistant fabric	✓
Colour	Single / Multi
Powder Coated	✓

**1** Self standing  
Single module

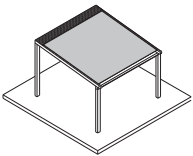

**2** Self standing  
Double module

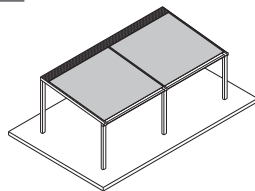

**3** Self standing  
Six modules

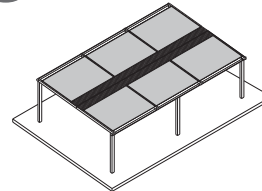

**4** Wall-mounted  
Single module

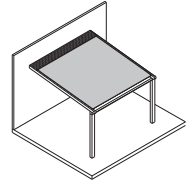

**5** Wall-mounted  
Double module

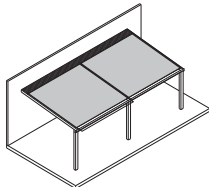

**6** Wall-mounted  
Triple module

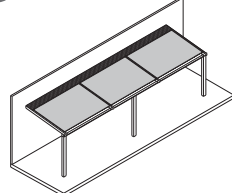

**7** Wall-mounted on two sides  
Single module

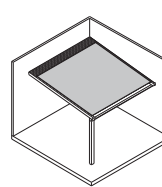

**8** Wall-mounted on two sides  
Double module

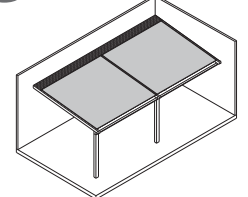



# MATEK GRUP LUNA HAS SOMETHING FOR EVERY SPACE SLEEK AND ELEGANT OR A TRADITIONAL LOOK



Aluminum



Stainless Component

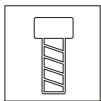

Motorized System

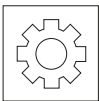

Remote Control



Light Proofing

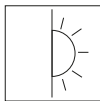

2 Years Warranty



Led Lighting



Eco Friendly



Water Proof

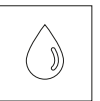

CE Certified

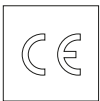

**MATEK GRUP**  
LIVING SPACE SOLUTIONS

Gümüşsuyu Cd. Fatih Şehitler Sk. No:4 Topkapı / ISTANBUL / TURKIYE  
+90 (212) 501 27 28 - info@matekgrup.com.tr / www.matekgrup.com.tr

f @ y matekgrup

ONLINE CATALOGUE  
FOR ALL PRODUCTS

